

WISHBONE OUTHOUSE BUILDING ASSEMBLY GUIDE

THE JOHN JUMBO OUTHOUSE (Model PTR-6-J)

THE FOREST JUMBO OUTHOUSE (Model FSTB-1-J)

THE JOHN WHEELCHAIR OUTHOUSE (Model PTR-80-WC)

THE FOREST WHEELCHAIR OUTHOUSE (Model FSTB-1-WC)



Wishbone
site furnishings

PARTS LIST

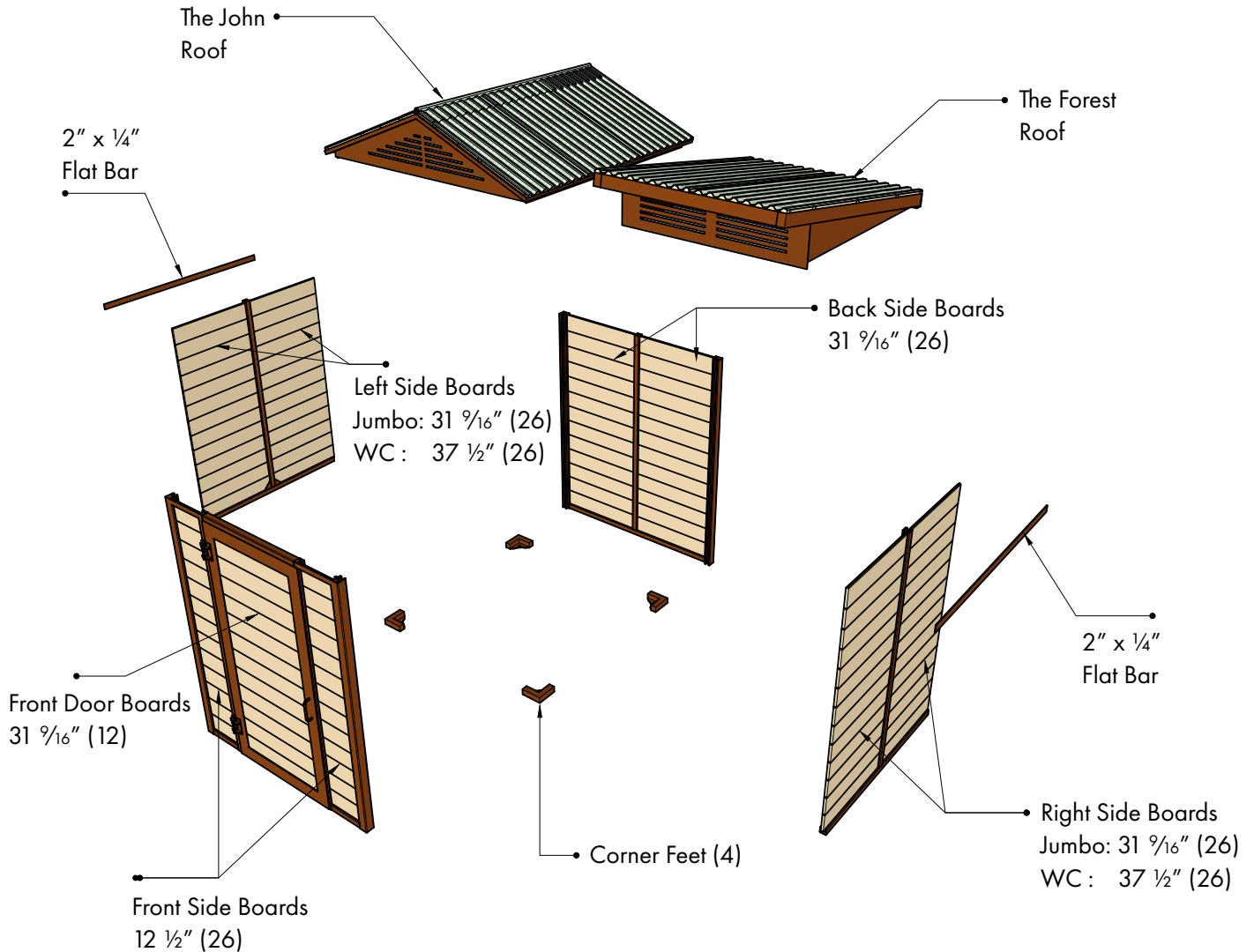

Hardware

- SP0607 1/4" x 3/4" Button Head Bolt (12/16)
- SP0610 1/4" x 1 1/4" Button Head Bolt (8/16)
- SP0809 3/8" x 1" Button Head Bolt (16/16)
- SJ0614 1/4" x 2 1/4" Carriage Bolt (4/4)
- SU0611 1/4" x 1 1/2" Hex Cap Bolt (1/1)
- SA0605 1/4" Hex Nut (15/19)
- SB0505 1/4" Flat Washer (4/8)
- SJ0610 1/4" x 1 1/4" Carriage Bolt (10/10)
- 1/2" x 6 5/8" ID U-Bolt (1/1)

Wall Lumber

- Side Wall (52)
- Back Wall (26)
- Front Wall (26)
- Door (12)

Jumbo

- 31 9/16"
- 31 9/16"
- 12 1/2"
- 31 9/16"

Wheelchair

- 37 1/2"
- 31 9/16"
- 12 1/2"
- 31 9/16"

Required Tools

- 5/32" Allen Key
- 7/32" Allen Key
- 10" Crescent Wrench
- 7/16" Wrench or Socket
- 1/4" Nut Driver
- 17/64" Drill
- 2 Small Step Ladders

Note: Extra hardware included for different outhouse configurations/options.

Above list shows hardware (required/included).
Extra lumber included for repairs.

INSTALLATION GUIDE

- 1 Two people are recommended for outhouse assembly.**
Position the front and back panels with the channels facing up as shown. Do not remove the locking bolt in the door until the door is levelled and secured in step 6.

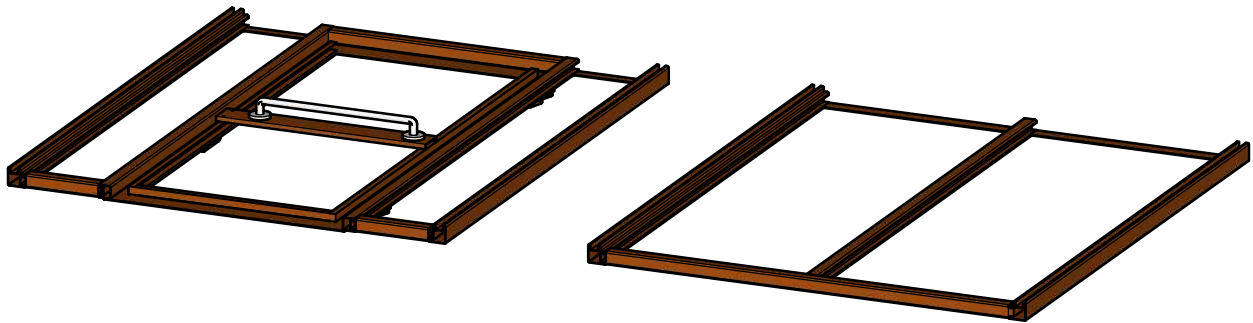

- 2 Attach the four corner feet to the bottom of the front and back panels.**

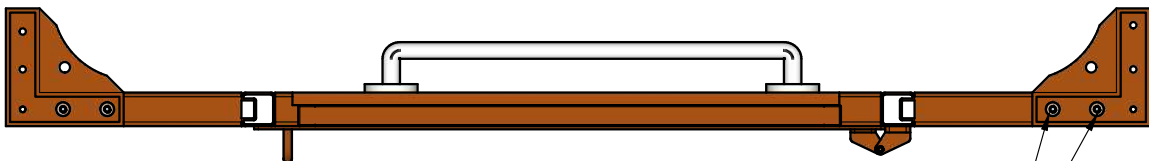

Attach with SP0809 ($\frac{3}{8}$ " x 1") button head bolts (8)

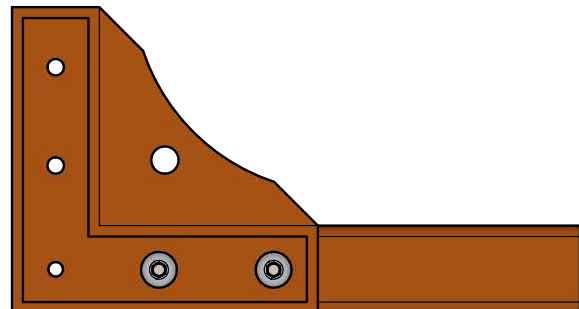
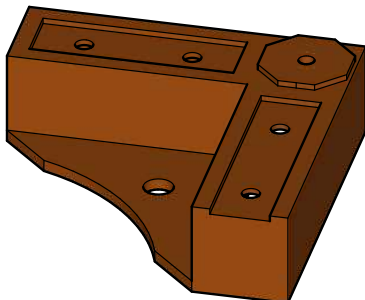

3 Stand the panels on edge with the channels facing each other as shown. Attach the flat bar side support to the top of the panels on one side of the frame.

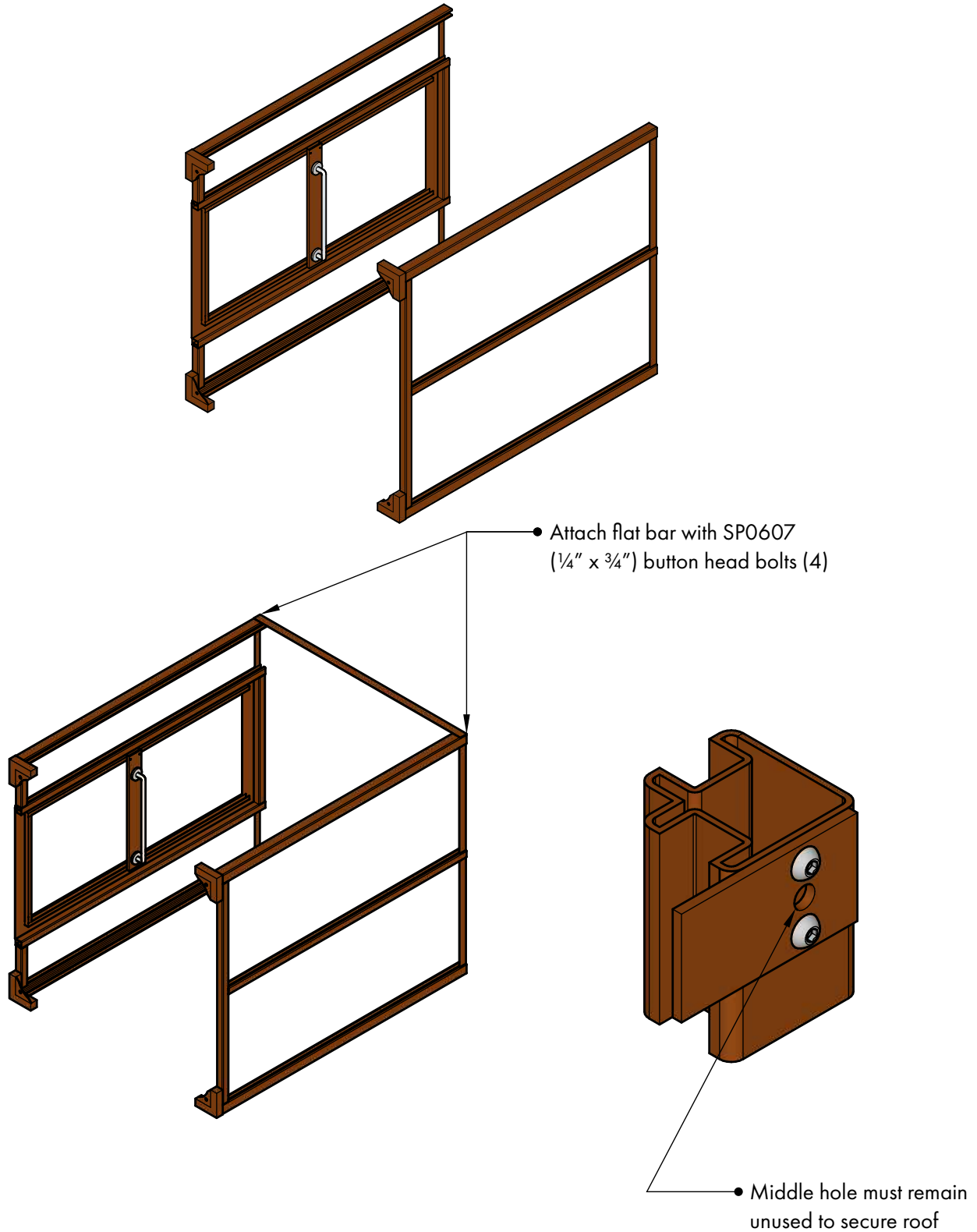

- 4** On the same side of the frame, loosely attach the T-shaped side support to the upper flat bar before attaching the lower part of the T-shaped support to the corner feet. Tighten all bolts at the end.

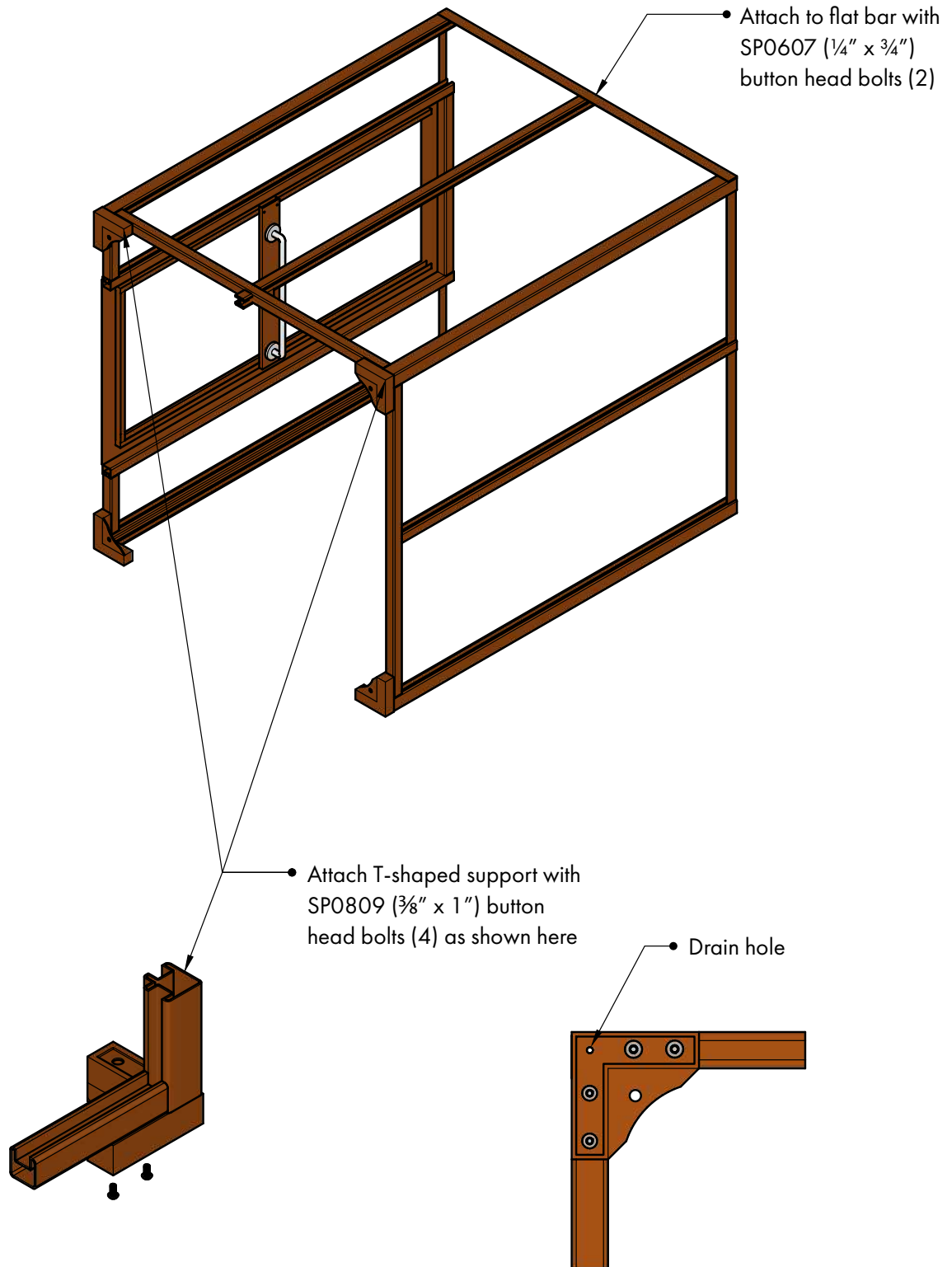

5 Turn over the frame and attach the remaining side supports as in steps 3 and 4. First attach the upper flat bar. Then loosely attach the top of the T-shaped support to it before attaching the bottom to the corner feet. Tighten all bolts when square.

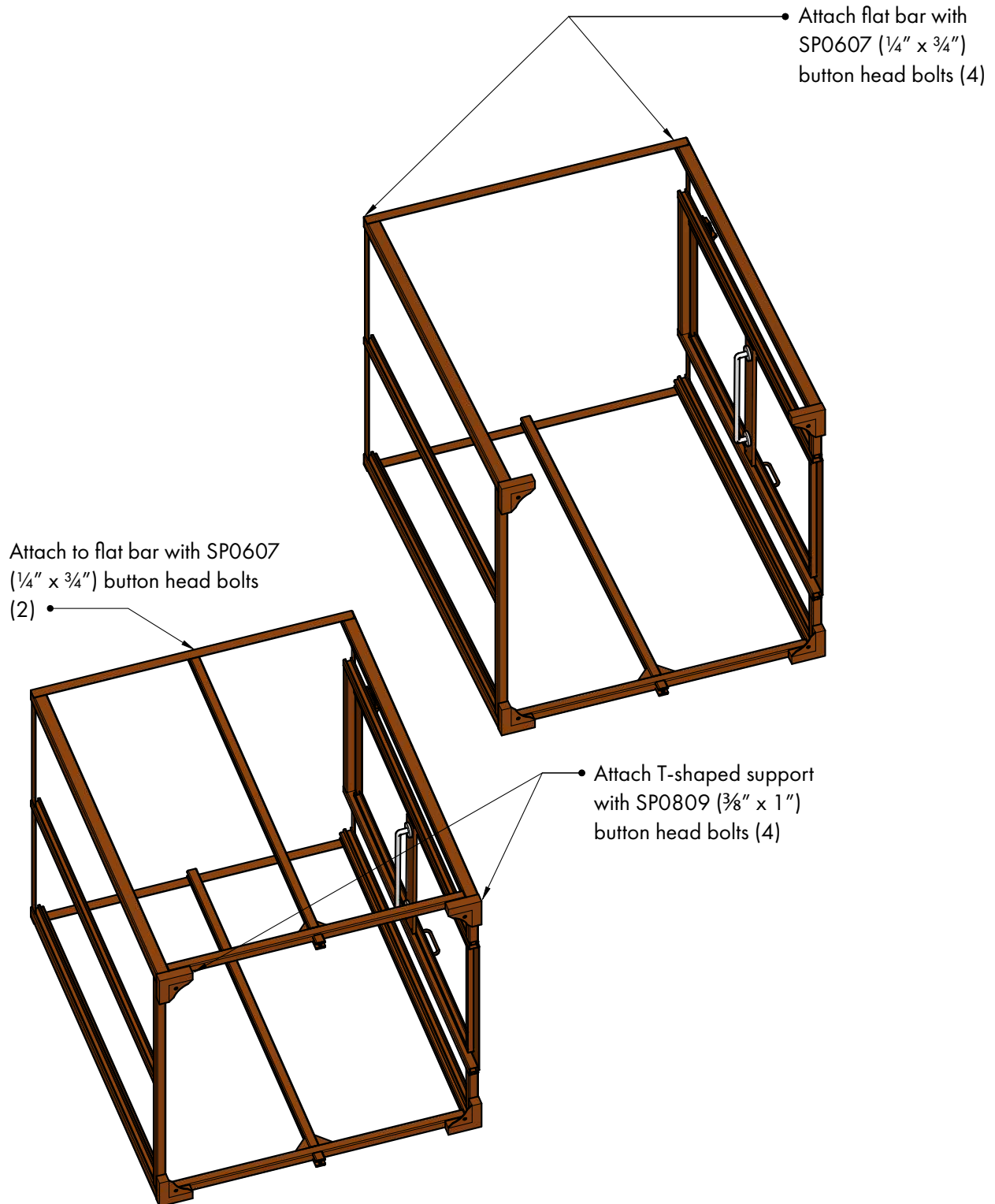

6 Stand up the outhouse frame in the location to be secured. Level and square the frame before appropriately securing it to the pad or ground with fasteners supplied by the installer. Spacers under the corner blocks may be required. Ensure the door moves freely and closes properly.

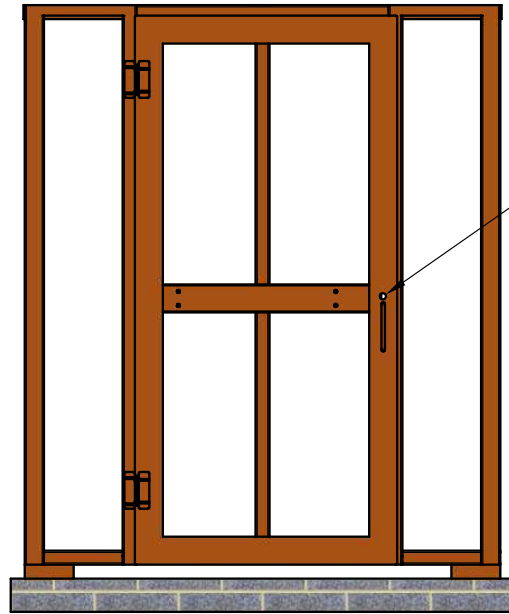

• Do not remove the locking bolt until the outhouse is levelled and secured

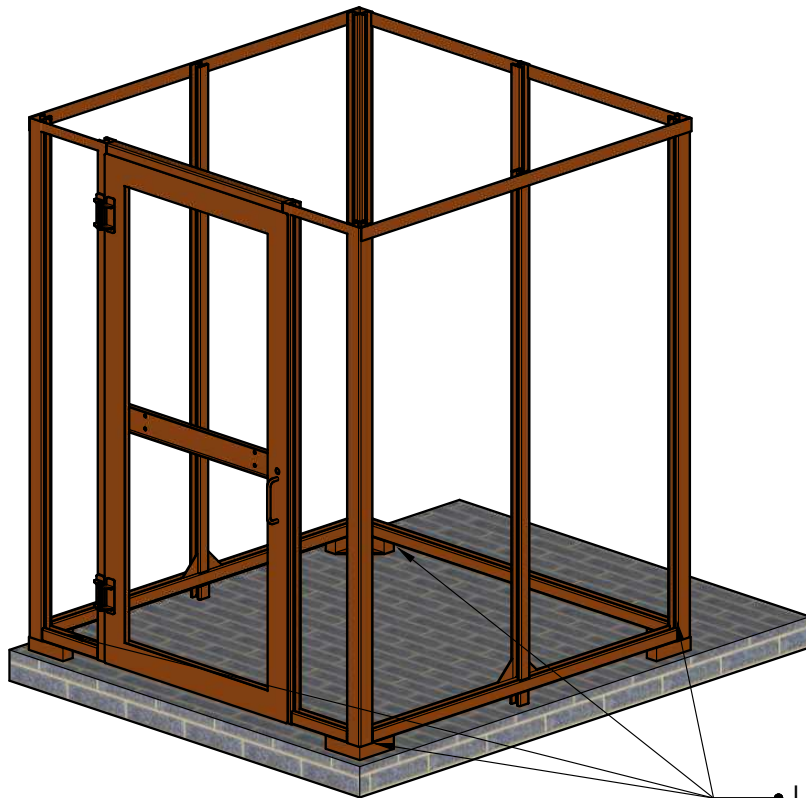

• Use $\frac{5}{8}$ " hole in corner blocks (4) to secure outhouse with installer-supplied fasteners, depending on application

7 Install the plastic lumber on the back side of the structure by sliding it down from the top. Ensure the groove side of the lumber faces down and the tongue side faces up. The textured side of the lumber faces out.

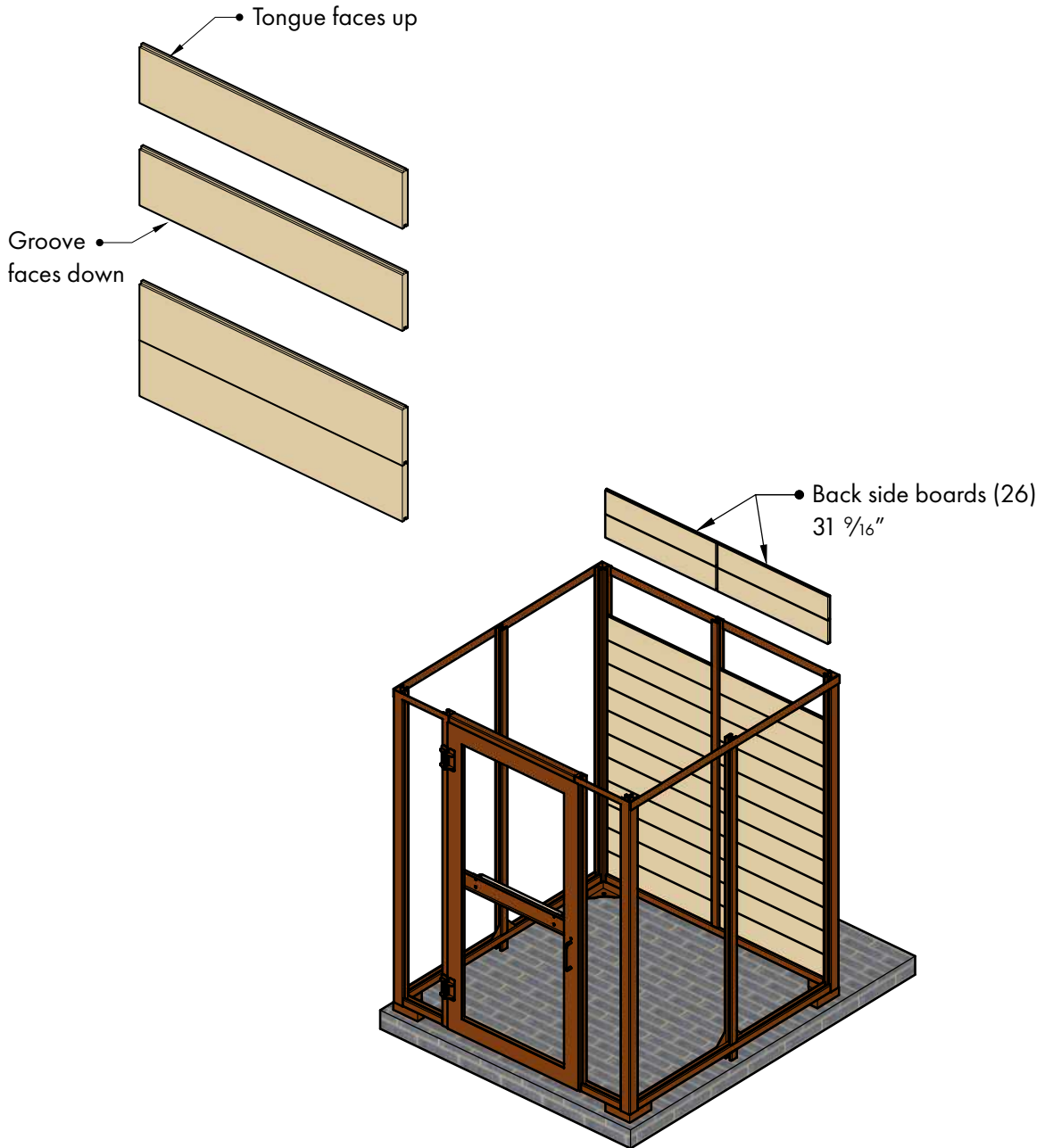

8 On the left side, slide in the plastic lumber from the top in the same way with groove down, tongue up, and textured side out.

Left side boards (26)
Jumbo: 31 $\frac{9}{16}$ "
WC: 37 $\frac{1}{2}$ "

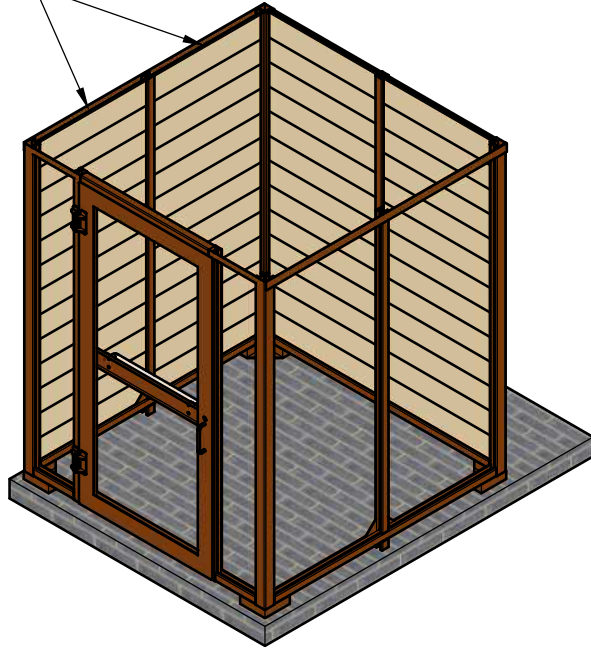

9 On the right side, slide in the plastic lumber from the top in the same way with groove down, tongue up, and textured side out.

Right side boards (26)
Jumbo: 31 $\frac{9}{16}$ "
WC: 37 $\frac{1}{2}$ "

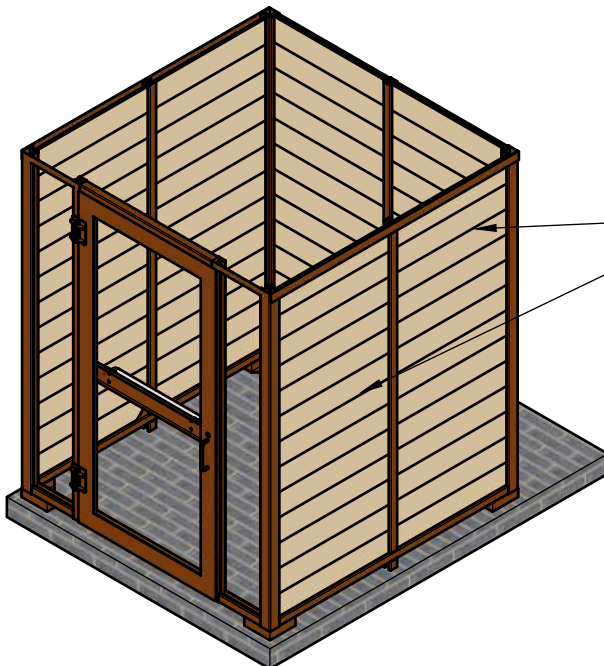

10 On the front, slide in the plastic lumber from the top in the same way with groove down, tongue up, and textured side out. Remove the aluminum angle and install the plastic lumber on the door last. Note decal board position.

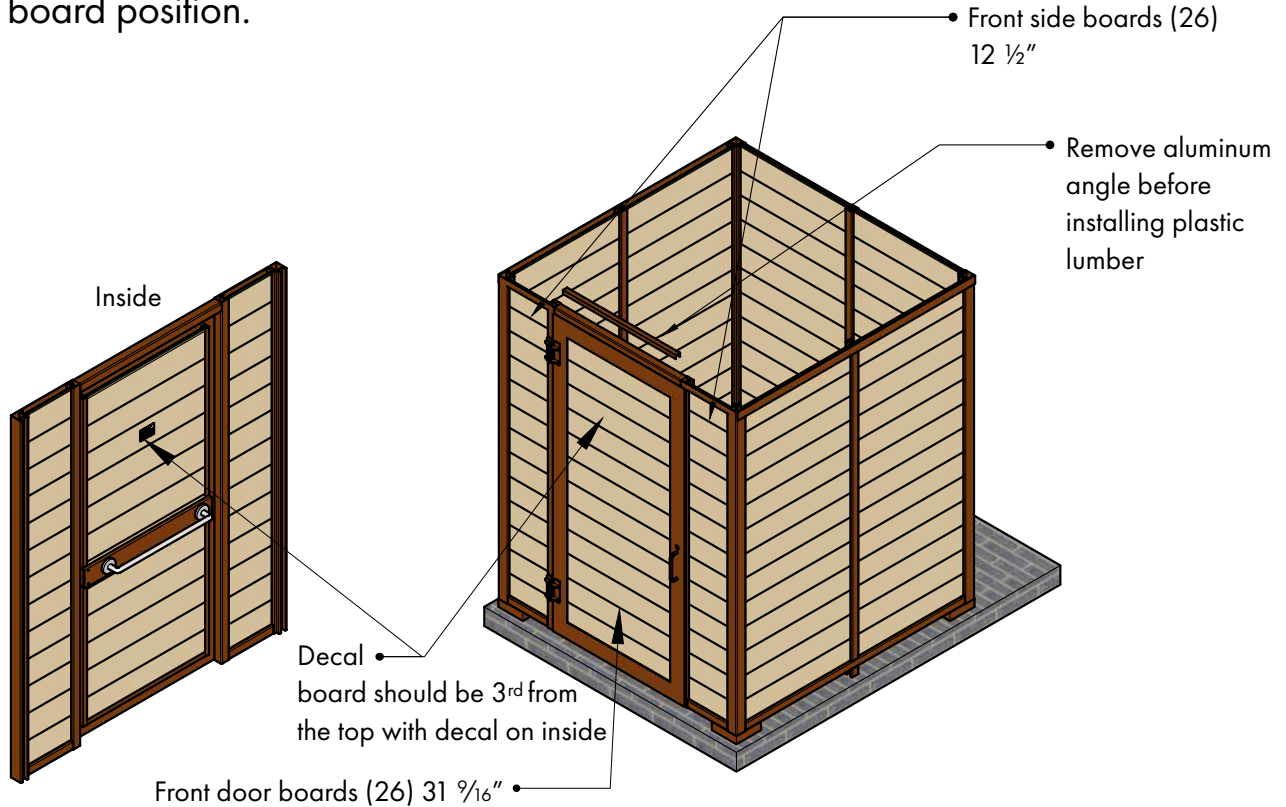

11 Re-install the aluminum angle back above the top board on the door.

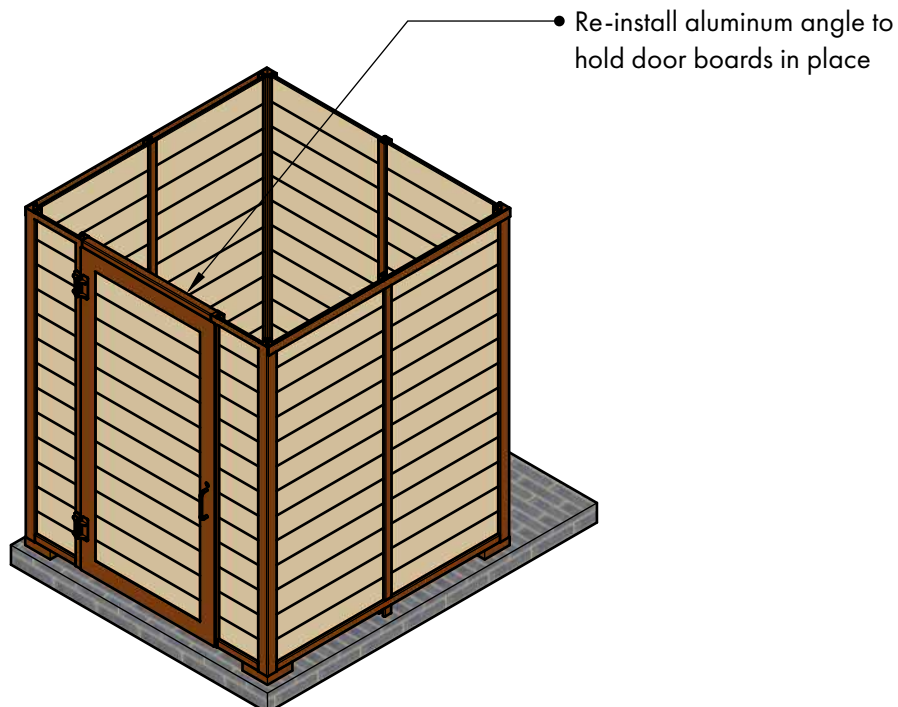

12 Position the roof and adjust the frame to line up all of the threads. Insert all fasteners loosely to ensure proper alignment before final tightening.

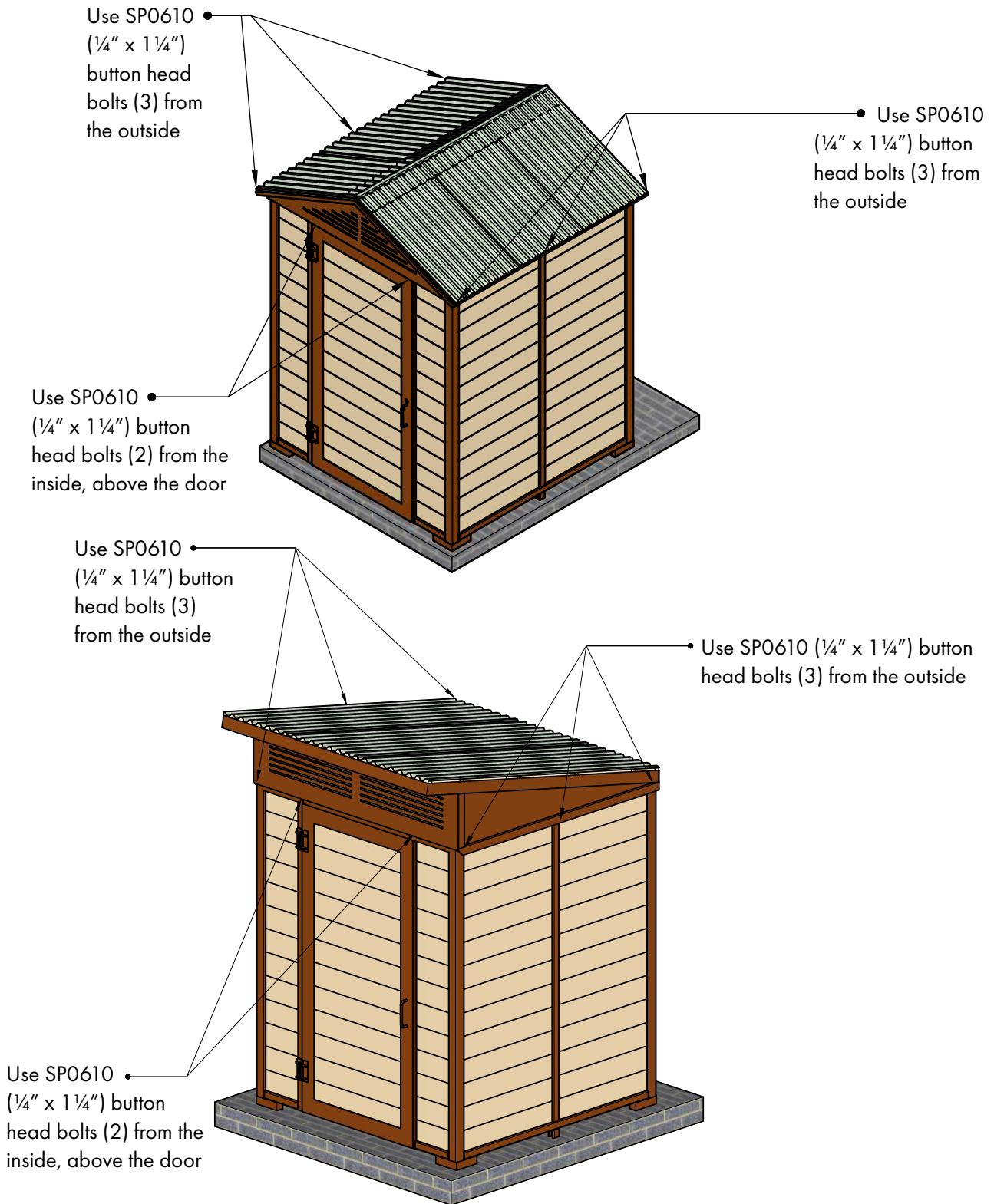

13 Install the vent stack into the ground or the concrete pad. Ensure the vent is straight and positioned vertically.

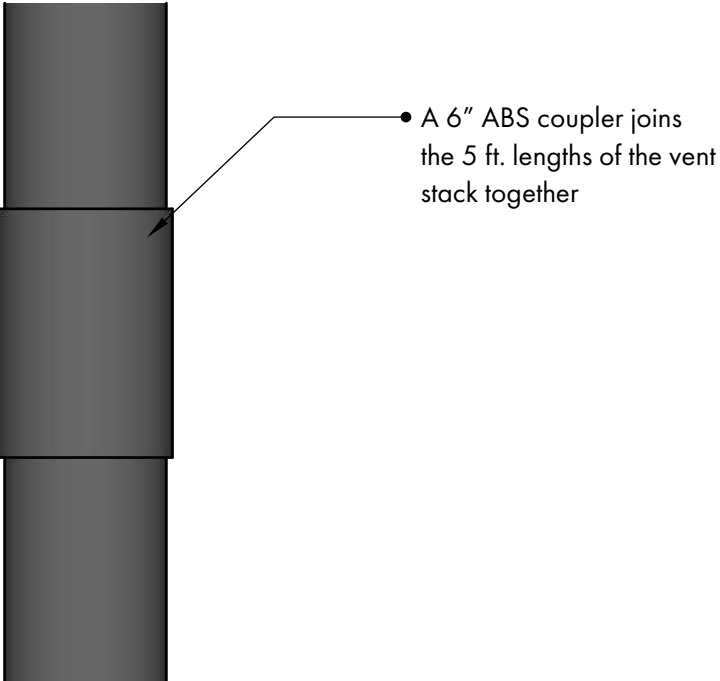
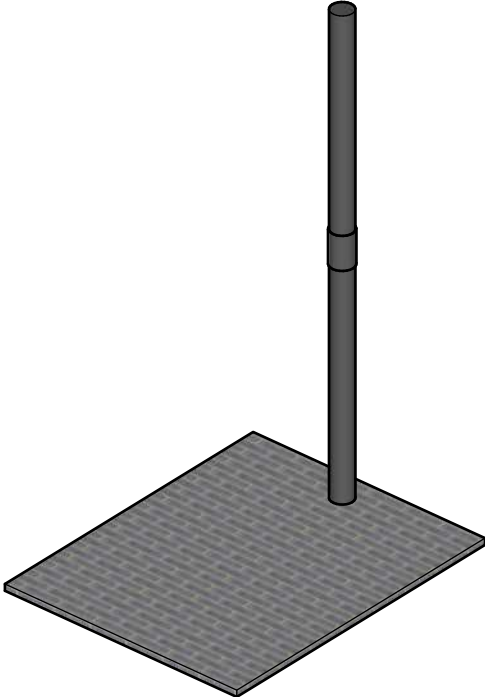

- 14** Adjust the length of the connecting fixture needed to secure the vent stack to the outhouse building.

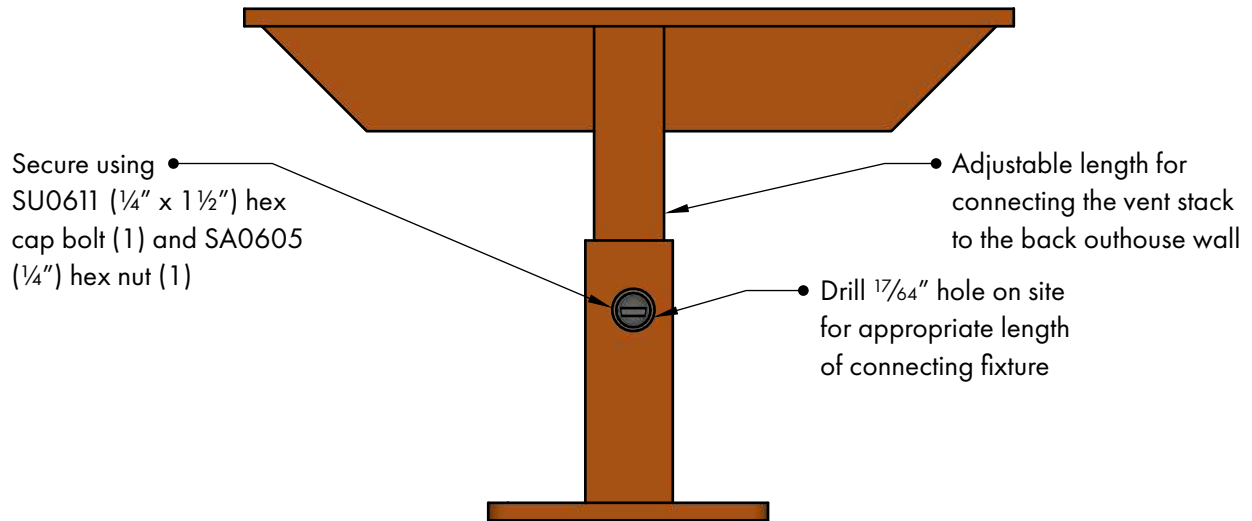

- 15** Install the connecting fixture to the back of the outhouse. If the stack must be in the middle of the outhouse, connect the fixture to the roof slots instead of the back wall.

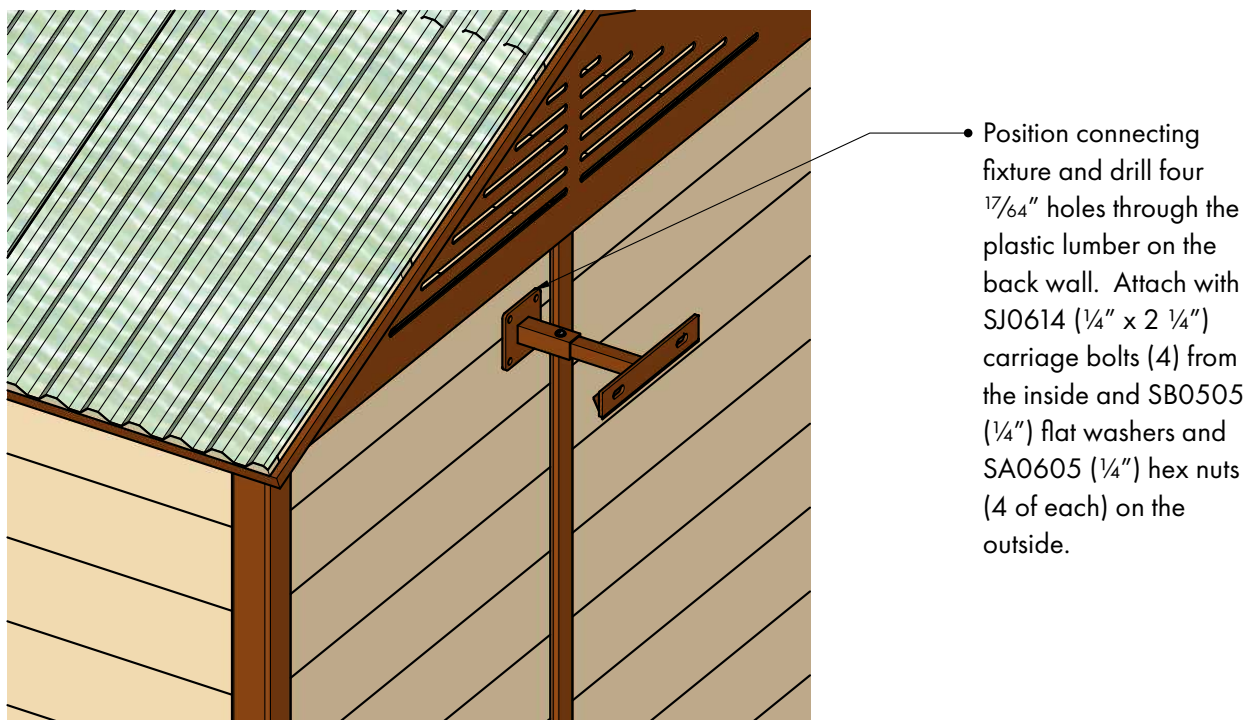

16 Attach the vent stack to the outhouse and secure using the U-bolt.

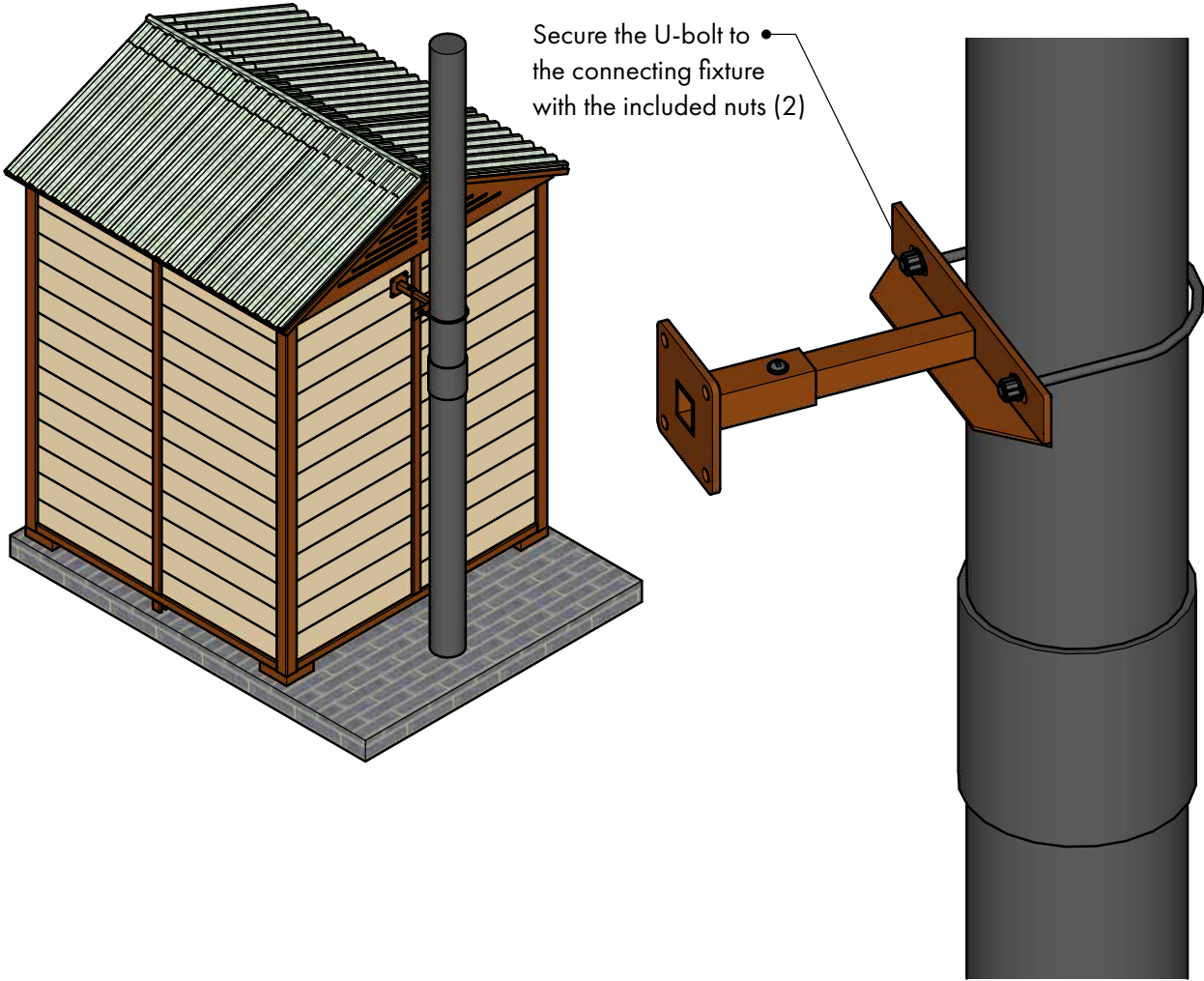

17 Install the horizontal grab bar on the back wall above the toilet and on the side wall nearest the toilet as shown. Position the bar correctly to mark the ten hole locations. Drill $1\frac{7}{64}$ " holes. Insert the carriage bolts from the outside and attach the grab bar with hex nuts on the inside.

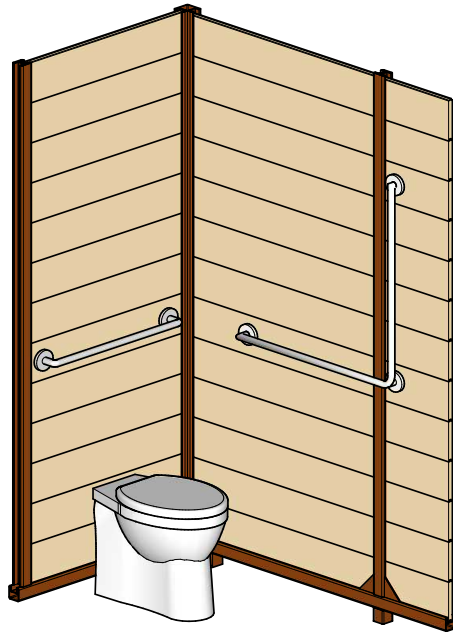

Use SJ0610 ($\frac{1}{4}$ " x $1\frac{1}{4}$ ") carriage bolts (10) from the outside and SA0605 ($\frac{1}{4}$ ") hex nuts (10) to install the grab bars around the toilet as indicated

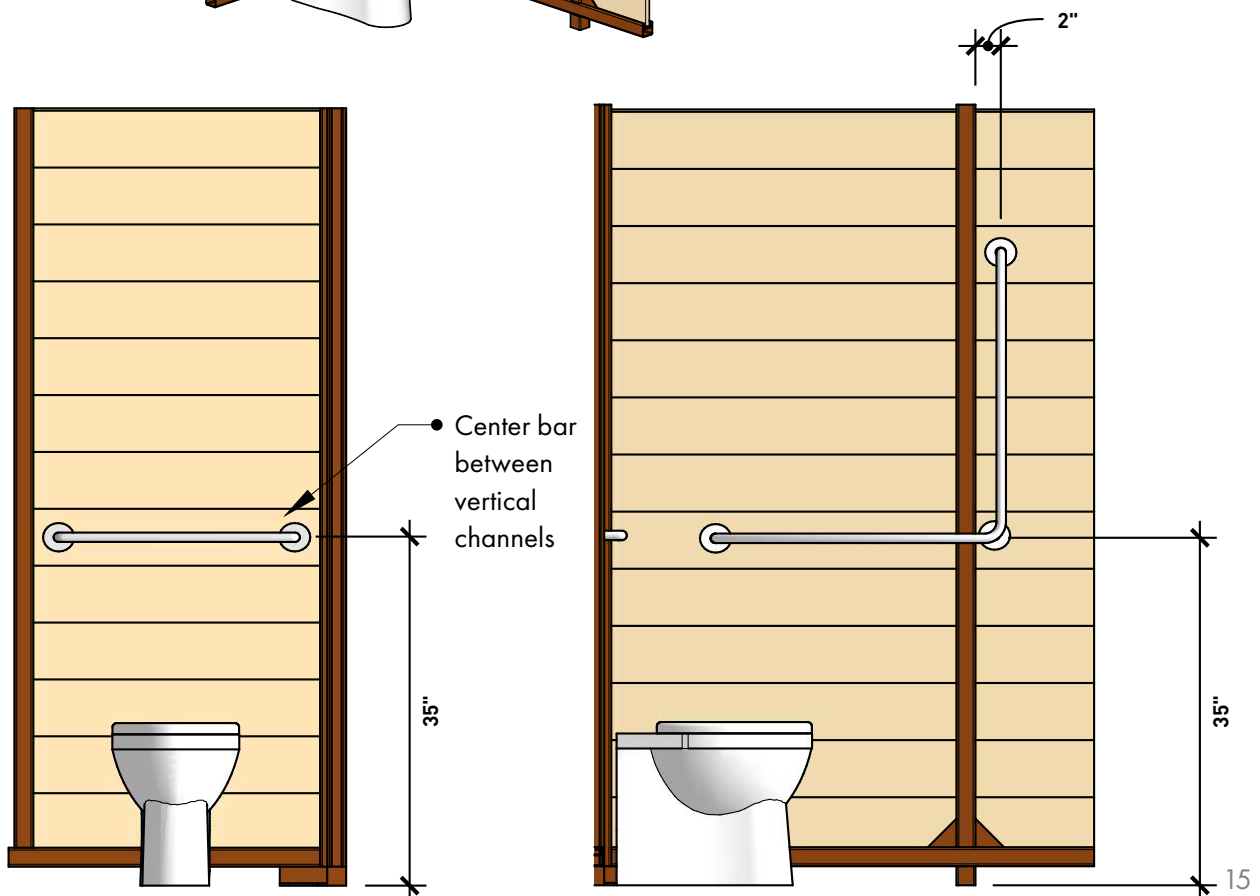

18 Your Wishbone outhouse building is complete. Enjoy!

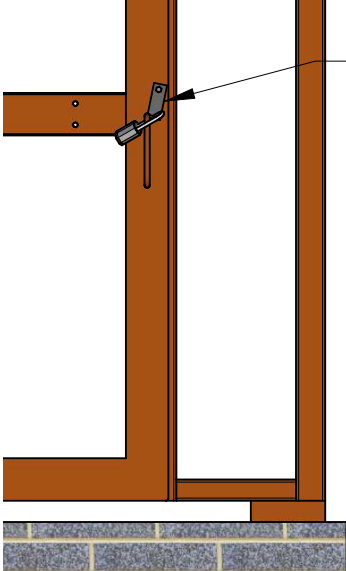
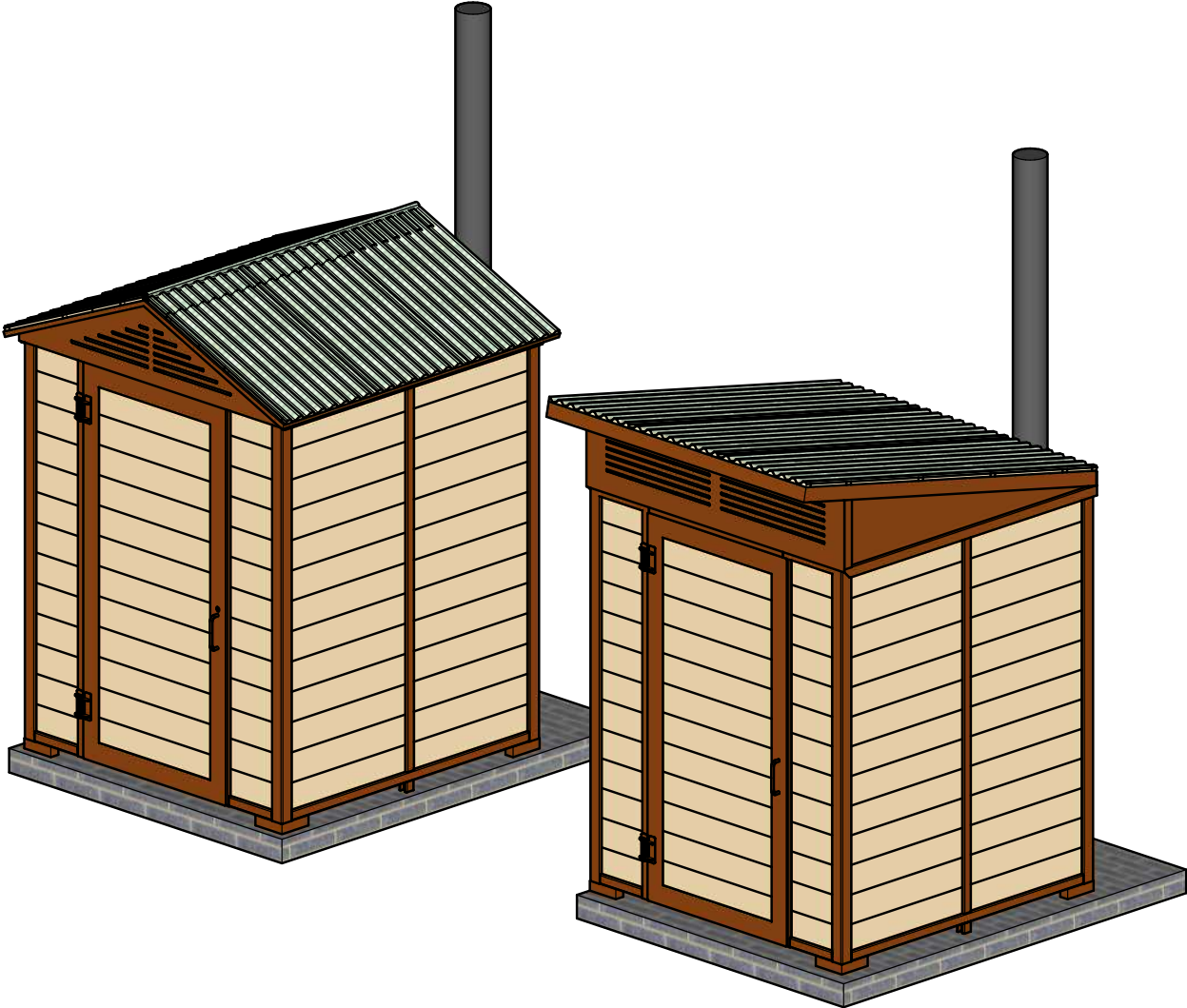

- Keep the locking bolt for use in decommissioning the outhouse with an appropriate padlock

CLEANING AND MAINTENANCE INSTRUCTIONS

Plastic Lumber

For basic cleaning, use a mild soap/detergent or a water/vinegar solution and a stiff-bristled brush. Rinse clean with running water.

Minor scratches can be repaired by using a standard electric heat-gun (or hand held acetylene torch) and a metal putty knife to heat and smooth the plastic. Test on a non-visible area first to practice.

Include an annual power-wash of the plastic lumber in your maintenance schedule. Maintain a distance no closer than 4-5 inches, and pressure no greater than 1200psi.

Specific problems:

- Grease stains: use a household grease remover
- Mould: use a mild soap solution
- Rust: use a mild soap solution
- Scratches or burns: use light sanding or brushing with a stainless steel brush

Aluminum Frame

Use mild soap, water, and a clean cloth to wipe down and wash the aluminum frames.

Roof

Clean the roof panels with warm water and a mild household detergent. Wipe off any remaining dirt with a soft cloth and wash again.

Pressure-washing is also suitable, but only when the nozzle is kept at least 20" (50 cm) from the sheet.

NEVER use solvent based cleaners (ammonia, etc.). NEVER wipe the sheets when dry. AVOID using sponges or brushes that can scratch the surface.

QUESTIONS OR COMMENTS?

Please contact us if you have any questions or comments on how we can improve this outhouse building.



#210-27090 Gloucester Way | Langley, BC | Canada | V4W 3Y5
Sales@WishboneLtd.com | WishboneLtd.com
Tel 604.626.0476 | Fax 604.626.0496

Call Us Toll Free at 866.626.0476